



Manufacturer
Brunner-Anliker, Swiss Made

Model
XL-C Star

The ideal vegetable cutter with up to 50 different cutting options for restaurants, catering businesses, nursing homes and hospitals, and an output of up to 1,000 meals.

Tender specification	
Design	<ul style="list-style-type: none"> Large kidney-shaped filler neck 2,100 cm³ Rotating filler neck on the right for the cutting of Brunoises and Gaufrettes Tool-free removal of top and plunger Carry handle on the back Electric cable 3 m long Plunger made of fiberglass composite with antimicrobial effect Cutting discs with a diameter of 240 mm (ceramics / PTFE coating) Ceramics / PTFE coating, made entirely of noncorroding material Extra protection by micro-fuse Maintenance/service-free gear motor
Function	Cutting, shredding, grating and grinding in up to 50 different ways
Capacity	Up to 300 Kg/h
Voltage	115 V, 60 Hz, (231.02510)
Space requirements	305 x 655 x 590 mm
Noise	40 dB
Weight	29.5 Kg
Certificates	CE, CSA, UL
Design and dimensions (in cm)	

Accessories

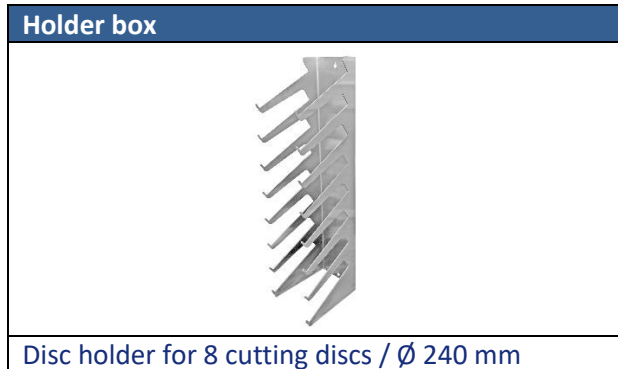

Recommended standard disc set

Star Kit (5 discs)	
Fine cut 1 mm	F1
Rough cut 3 mm	G3
Juliennes 2 mm	S2
Grating disc for hash browns	Nr. 0
Brunoises 3 mm	BR3

Disc overview

	Sickle knife	Art. Nr.
Sickle knife 1.5 mm	SM 1.5	232.02675
Sickle knife 2.5 mm	SM 2.5	232.02676
Sickle knife 4.5 mm	SM 4.5	232.02678

	Allumettes	Art. Nr
Allumettes 4 mm	PA 4	232.02631
Allumettes 4 mm (cheese)	PA 4 K	232.02232
Allumettes 5 mm	PA 5	232.02633
Allumettes 5 mm (cheese)	PA 5 K	232.02634
Allumettes 6 mm	WS	232.02240

	Rough cut	
Rough cut 3 mm	G3	232.02603
Rough cut 4 mm	G4	232.02288
Rough cut 6 mm	G6	232.02606
Rough cut 8 mm	G8	232.02236
Rough cut 10 mm	G10	232.02237
Rough cut 12 mm	G12	232.02238
Rough cut 16 mm	G16	232.02552

	Brunoises	Art. Nr.
Brunoises 3 mm	BR 3	232.02639
Brunoises 4 mm	BR 4	232.02640
Brunoises 5 mm	BR 5	232.02641

	Bâtonnets	Art. Nr.
Bâtonnets 6 mm	BT 6	232.02241
Bâtonnets 7 mm	BT 7	232.02242
Bâtonnets 8 mm	BT 8	232.02243
Bâtonnets 10 mm	BT 10	232.02244

	Shaving cut	Art. Nr.
Shaving cut 0.5mm	HS	232.02621

	Demidov	Art. Nr.
Demidov 5 mm	SU 5	232.02298
Demidov 7 mm	SU 7	232.02258

	Gaufrettes	Art. Nr.
Gaufrettes 4 mm	PG 4	232.02286
Gaufrettes 8 mm	PG 8	232.02293

	Tomato cut	Art. Nr.
Tomato cut 5 mm	TO	232.02614

	Cubes	Art. Nr.
Cubes 6 mm	W 6	232.02245
Cubes 8 mm	W 8	232.02247
Cubes 10 mm	W 10	232.02248
Cubes 14 mm	W 14	232.02250
Cubes 24 mm	W 24	232.02251

	Grating discs	Art. Nr.
Grating disc 13 mm	No 000	232.02259
Grating disc 11 mm	No. 00	232.02260
Grating disc 9 mm	No. 0	232.02700
Grating disc 7 mm	No. 1	232.02701
Grating disc 6 mm	No. 2	232.02702
Grating disc 5 mm	No. 3	232.02551
Grating disc 4.2 mm	No. 4	232.02265
Grating disc 3 mm	No. 7	232.02266
Grating disc 2.5 mm	No. 9	232.02267
Grating disc 2 mm	No. 11	232.02268
Grating disc 1.8 mm	No. 12	232.02712
Parmesan	No. 14	232.02270
Fondue 12 mm	No. 18	232.02718
Fondue 16 mm	No. 19	232.02719
Universal 2.5 mm	No. 23	232.02723

	Fine cut	Art. Nr.
Fine cut 1 mm	F1	232.02601
Fine cut 2 mm	F2	232.02602